

Product

IT9121 & IT9121E Power Meters

Features



Harmonic Measurement

High Precision Measurement

Integral Measurement Function

IT9121 & IT9121E Power Meters

APPLICATIONS

- Power Supplies Tests
- Motor Tests
- Household Appliances Tests
- Electronics
- Energy Star
- Test Systems

Your Power Testing Solution



IT9121 & IT9121E Power Meters

The IT9121 power meter can provide the maximum input of 600 Vrms and 20 Arms and measurement bandwidth of 100 KHZ, and can be easily used for measuring the voltage, current, power, frequency, harmonics and other parameters. The only difference between IT9121 and IT9121E is harmonic measurement function. IT9121E doesn't have harmonic measurement function. The standard configuration includes USB, GPIB, RS232 and LAN communication interfaces and also interfaces for USB-based peripheral devices. Users can save the measured parameters into the external storage medium. The basic voltage and current accuracy is 0.1%. Moreover, the power meter has rich integrating functions, such as the active power. It is widely applied in test of motors, household appliances, UPS, etc.

Features

- 4.3-inch color LCD (TFT)
- The row number of matrix displayed on the screen can be set freely and common measurement parameters can be displayed
- Input range: 600 Vrms / 20 Arms
- The voltage, current, power, harmonics and other parameters can be measured at the same time
- The accuracy of voltage and current measurement is up to 0.1%
- The power meter has a function of harmonic measurement, and can be used for measuring up to 50th harmonics
- The interfaces for USB-based peripheral devices are provided, and the user can save data into the external storage medium
- The power meter has rich and powerful integrating functions, and can be used for measuring electric energy which is bought or sold
- The power meter also has a function of frequency measurement
- Standard built-in USB, GPIB, RS232 and Ethernet communication interfaces

Application

With precision measurement and multi-function, IT9121 and IT9121E are ideal for measuring and inspecting all types of electronic devices with switching power supplies. It can be used in both R&D, production test and other applications.

- Uninterruptible Power Supply (UPS) test
- Power supply test
- Appliances standby power consumption test
- Energy Star test
- Motor test
- Test system

Electronic devices with power source unit

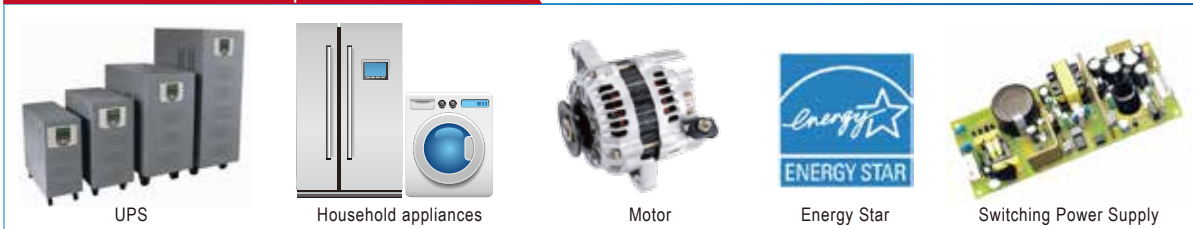

Your Power Testing Solution

IT9121 & IT9121E Power Meters

Application Advantages

Power supply test

Due to the features of small size, light and high efficiency, the switching power supplies are widely applied on nearly every kind of electronic device. To restricting the harmonic pollution to the grid caused by the switching power supply, it is necessary to do the relating test in research and production procedures to make sure that the switching power supplies can comply with the international standard. IT9121 and IT9121E are available to provide complete test solution for switching power supplies.

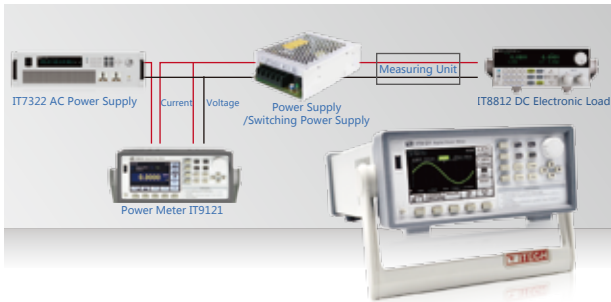

- Input voltage/current (RMS): Urms/ Irms
- Peak voltage Up-p/ Current Ip-p
- Active Power (W)
- Reactive power (VAR)
- Apparent power (VA)
- Maximum Voltage Upk+ and Minimum Voltage Upk-
- Maximum Current Ipk+ and Minimum Current Ipk-
- Crest factor (CF)
- Power factor (PF)

Appliances standby power consumption test

Each country has their own standard on standby power consumption of appliances. IT9121 power meter supports multiple measurements like power factor, harmonic, efficiency, power consumption and crest factor etc.



Energy Star

For external power supply products, the regulation--"Energy Star" can judge whether power supply models have high efficiency conversion either on AC/DC or AC/AC.

With 5mA minimum scale range and 5 bits measurement display, IT9121 not only can accurately measure the standby current but also be able to figure out the power consumption which completely satisfies the "Energy Star" requirements.

1.1 and 2.0 version regulation of "Energy Star" external power supply by United States environmental protection agency

EPA1.1	
output power Rating in operation mode (P_{op})	Minimum efficiency requirements under operation mode
$0 < P_{op} \leq 1$ W	$\geq 0.49 \cdot P_{op}$
$1 < P_{op} \leq 49$ W	$\geq 0.09 \cdot L_{(P_{op})} + 0.49$
$P_{op} > 491$ W	≥ 0.84
Rating output power in empty load mode (P_{eo})	Maximum power consumption requirements in empty load mode
$1 < P_{eo} < 10$ W	≤ 0.5 W
$10 \leq P_{eo} \leq 250$ W	≤ 0.75 W

EPA2.0	
Minimum efficiency requirements in operation mode	
Standard operation mode	Low voltage operation mode
$\geq 0.480 \cdot P_{op} + 0.140$	$\geq 0.480 \cdot P_{op} + 0.067$
$\geq 0.0626 \cdot L_{(P_{op})} + 0.622$	$\geq [0.075 \cdot L_{(P_{op})}] + 0.561$
≥ 0.870	≥ 0.860
Maximum power consumption requirements in empty load mode	
AC-ACEPS	AC-DCEPS
≤ 0.5 W	≤ 0.3 W
≤ 0.5 W	≤ 0.5 W



Motor test

The speed control of industrial products uses PWM methods. IT9121 and IT9121E power meters are able to measure DC input signal with 0.5Hz-100 kHz bandwidth and input voltage up to 600V. The current can be supplied though an external transformer.

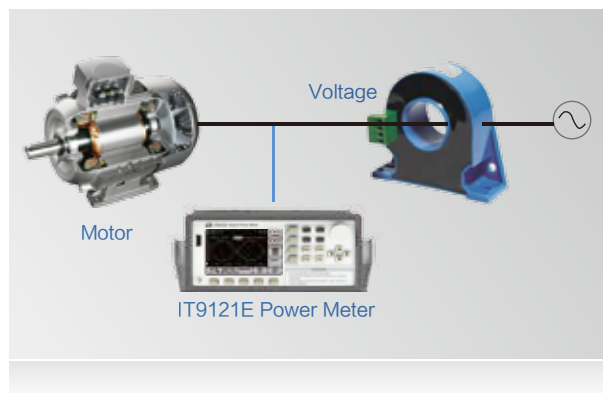

Your Power Testing Solution

IT9121 & IT9121E Power Meters

Harmonic Measurement

The IT9121 power meter has a bandwidth of 100KHz, which can realize high-speed harmonic measurement within a wider dynamic range. In the harmonic mode, the voltage, the current, the active power, reactive power and phase of each harmonic and the factor of total harmonic distortion (THD) can be tested. In addition, IT9121 can be used for measurement of multiple harmonics, 50 harmonics of the fundamental frequency can be measured at most.

The parameters of each harmonic measured by the IT9121 power analyzer can be displayed in the bar chart and the list, so as to facilitate analysis of measurement results.



* IT9121E does not have harmonic measurement function.

TFT High-resolution LCD

IT9121 & IT9121E provides a 4.3-inch color high-resolution TFT LCD for the user, and real-time values can be displayed with high brightness and remarkable colors even in a dark test environment.

In addition, the IT9121 power meter provides multiple interface display styles (View1, View4 and View12). The user can customize the screen display parameter type and display sequence, and roll over the screen display via the keys "Left" and "Right". The humane design meets engineers' measurement demands in different tests.



Rich Measurement Functions

The IT9121 power meter can measure all AC and DC parameters, including the active power, reactive power, apparent power, power factor, voltage, current, frequency, phase difference, etc. It also has the function of integral measurement and up to 50th harmonic measurement, and can display single harmonic components. It is widely applied in tests of motors, household PCB, UPS, etc.



Current Transducer Input

The IT9121 & IT9121E power meter can be used for measuring the voltage of 0-600 V and current of 0-20 A. For measurement of the current above 20 A, the voltage input type current clamp or current transducer can be applied. When IT9121 is used, the user can select the range of 50 mV-2 V (EX1) or 2.5 V-10 V (EXT2).



Your Power Testing Solution

IT9121 & IT9121E Power Meters

Oscilloscope function

IT9121 & IT9121E power meter can display the waveform basing on sampling data. You can chose to display or hide the waveform of the input voltage and current.

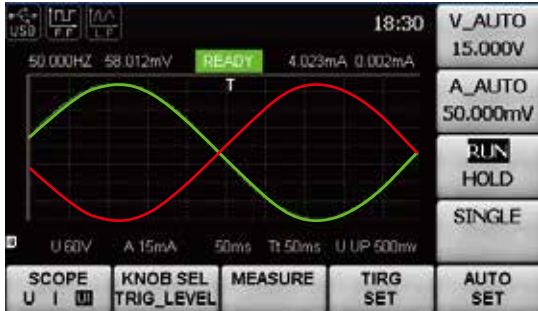

Integral Measurement Function

Due to the power integral function, the sold/bought electric energy in the interconnected power grids can be measured. The IT9121 & IT9121E power analyzer can provide the current integral and active power integral (Wh). Automatic range switching and accurate integral measurement can be carried out in the Buy and Sell mode, according to the input level.



Optional accessory

IT-E185 The testing fixture box(250V/15A)



Built-in multi-interface

In conventional test instrument, extra interfaces add cost. IT9121 & IT9121E provide multiple built-in interfaces including USB, GPIB, RS232 and Ethernet communication interfaces on rear panel. And the USB interface on the front panel can save data into external storage medium. Simplifying the configuration process and adding flexibility to change interface used without adding additional cost.

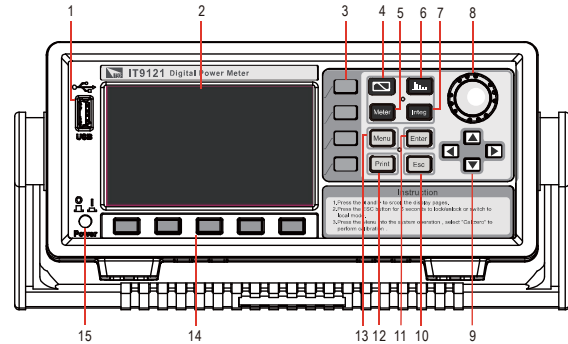

- | | |
|-------------------------|---------------------------|
| 1 USB Interface | 9. Arrow keys |
| 2. Display | 10. Hold/Esc key |
| 3. Menu key | 11. Enter key |
| 4. Waveform Display key | 12. Image Save key |
| 5 Basic functions | 13. Parameter setting key |
| 6. Harmonic key | 14. Menu key |
| 7. Integrator key | 15. Power switch |
| 8. Setting knob | |

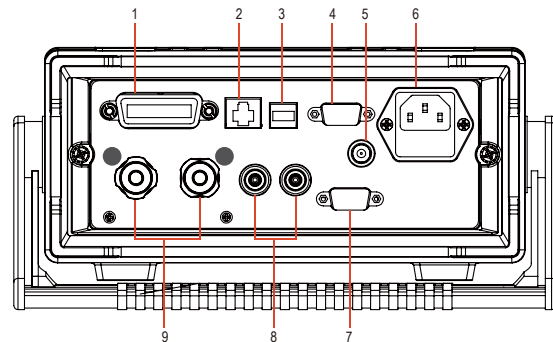

1. GPIB interface
2. Ethernet interface
3. USB Interface
4. RS232 interface
5. External synchronization signal interface
6. Power interface
7. External sensor interface
8. Voltage input terminal
9. Current input terminal

Your Power Testing Solution

IT9121 & IT9121E Power Meters

Specification

General Specification

Model	IT9121 & IT9121E
AC input voltage	100 VAC—240 VAC 50 / 60 Hz
Warm-up time	Approx 30 minutes
Operating environment	Temperature : 5 C— 40 C Humidity : 20% RH—80% RH (No condensation) Altitude : 2000 m or less 2000 m
Storage environment	Temperature : -20 C— 50 C Humidity : 20% RH—80% RH (No condensation) Altitude : 2000 m or less 2000 m
Installation	Indoors
Safety	IEC 61010-1, EN 61010-1, Measurement CAT
Maximum power consumption	50 VA

Screen Display

Detailed Information

Display type	Dimension : 4.3-inch color LCD (TFT) Full screen pixel: 480 (horizontal) *272 (vertical) points Waveform display pixel: 384 (horizontal) *194 (vertical) points Operating temperature: -20 C~ 70 C Storage temperature: -30 C~ 80 C Value display: matrix display
--------------	--

Input

Item	Specifications
Input terminal type	voltage; plug-in terminal (safety terminal)
Input type	Current Direct input: large binding post External current sensor input DB9 connector
Input type	Voltage: Floating input through resistive voltage divider Current: Floating input through shunt
Measure range	Voltage: 15 V, 30 V, 60 V, 150 V, 300 V, 600 V Current: Direct input: 5 mA, 10 mA, 20 mA, 50 mA, 100 mA, 200 mA, 0.5 A, 1 A, 2 A, 5 A, 10 A, 20 A Sensor input: EX1: 50 mV, 100 mV, 200 mV, 500 mV, 1 V, 2 V; EX2: 2.5 V, 5 V, 10 V
Input impedance	Voltage: Input resistance: Approx. 2 MΩ, input capacitance: Approx. 13 pF (in parallel with the resistance) current: • Direct input range 5 mA ~ 200 mA: Input resistance: Appro x 505 mΩ Input inductance: Appro x 0.1 μH • Direct input range 0.5A ~ 20 A: Input resistance: Appro x 5 mΩ Input inductance: Appro x 0.1 μH • Sensor input: Input resistance: Appro x 100 kΩ (2.5 V ~ 10 V) Input resistance: Appro x 20 kΩ (50 mV ~ 2 V)
Continuous maximum allowable input	Voltage: peak value of 1.5 kV or RMS value of 1 kV, whichever is less • Direct input range 5 mA ~ 200 mA: peak value of 30 A or RMS value of 20 A, whichever is less • Direct input range 0.5 A ~ 20 A: peak value of 100 A or RMS value of 30 A, whichever is less • Sensor input : Peak value less than or equal to 5 times of the rated range
Instantaneous maximum allowable input (1s)	Voltage: peak value of 2 kV or RMS value of 1.5 kV, whichever is less

Instantaneous maximum allowable input (1S)	Current: • Direct input range 5 mA ~ 200 mA: peak value of 30 A or RMS value of 20 A, whichever is less • Direct input range 0.5 A ~ 20 A: peak value of 150A or RMS value of 40 A, whichever is less Sensor input : • Peak value less than or equal to 10 times of the rated range
Input bandwidth	DC, 0.5 Hz ~ 1 MHz
Continuous maximum Common-mode voltage	600 Vrms, CAT
Line filter	select OFF, cut off frequency of 500 Hz
Frequency filter	select OFF, cut off frequency of 500 Hz
Range	range of each unit can be set separately
A/D converter	Simultaneous conversion voltage an current inputs Resolution: 18-bit Maximum conversion rate: 10 μs

Voltage And Current Accuracy

Item	Specifications
Requirements	temperature: 23 ± 5 C humidity: 30~75% RH Input waveform: Sine wave crest factor: 3, common-mode voltage: 0 V Number of displayed digits: 5 digits (6 digits when including the decimal point) Frequency filter : Turn on to measure voltage or current of 200 Hz or 30 minutes after warm-up time has passed After zero-level compensation or measurement range is changed
Accuracy	DC: ± (0.1% of reading + 0.2% of range) 0.5 Hz ≤ f < 45 Hz: ± (0.1 % of reading + 0.2 % of range) 45 Hz ≤ f ≤ 66 Hz: ± (0.1 % of reading + 0.2 % of range) 66 Hz < f ≤ 1kHz: ± (0.1 % of reading + 0.2 % of range) 1 kHz < f ≤ 10 kHz: ± (0.1 % of reading + 0.2 % of range) ± (0.07 *f) % of reading + 0.3% of range) 10 kHz < f ≤ 100 kHz: ± (0.5 % of reading + 0.5 % of range) ± [(0.04x(f-10))% of reading]

Active Power Accuracy

Item	Specifications
Requirements	same as the conditions for voltage and current. Power factor:1
Accuracy	DC: (0.1 % of reading + 0.2 % of range) 0.5 Hz ≤ f < 45 Hz: ± (0.3 % of reading + 0.2 % of range) 45 Hz ≤ f ≤ 66 Hz: ± (0.1 % of reading + 0.1 % of range) 66 Hz < f ≤ 1kHz: ± (0.2 % of reading + 0.2 % of range) 1 kHz < f ≤ 10 kHz: ± (0.1 % of reading + 0.3 % of range) ± [(0.067x(f-1))% of reading] 10 kHz < f ≤ 100 kHz: ± (0.5 % of reading + 0.5 % of range) ± [(0.09x(f-10))% of reading]
Influence of power factor	when power factor (λ)=0 (S:apparent power) • ± 0.2 % of S for 45 Hz ≤ f ≤ 66 Hz • ± {(0.2 + 0.2 × f) % of S } for up to 100 kHz as reference data f is frequency of input signal in kHz when 0 < λ < 1 (Φ: phase angle of the Voltage and current) (power reading)×[(power reading error%)+(power range %)×(power range/indicated apparent power value)]+(tanΦ×(influence when λ=0)%)]
When the line filter is turned ON	45 ~ 66 Hz: Add 0.3 % of reading < 45 Hz: Add 1 % of reading
Temperature coefficient	same as the temperature coefficient for voltage and current
Accuracy when the crest factor is set to 6	accuracy obtained by doubling the measurement range error for the accuracy when the crest factor is set to 3
Accuracy of apparent power S	voltage accuracy +current accuracy
Accuracy of reactive power Q	accuracy of apparent power + (√1.0004 - λ2) - (√1 - λ2) ×100 %

Your Power Testing Solution

IT9121 & IT9121E Power Meters

Accuracy of power factor λ	$\pm [(\lambda - 1/1.0002) + \cos\theta - \cos\{\theta + \sin^{-1}(\text{influence from the power factor when } \lambda = 0\%/100)\}]$ ± 1 digit when voltage and current are at the measurement range rated input
Accuracy of phase difference Φ	$\pm [\theta - \cos^{-1}(1/1.0002) + \sin^{-1}(\text{influence from the power factor when } \lambda = 0\%/100)]$ ± 1 digit when voltage and current are at the measurement range rated input

Voltage, Current And Power Measurements

Item	Specifications
Measurement method	Digital sampling method
Crest factor	3 or 6
Wiring system	(one element model): single-phase , two-wire(1 P2 W)
Range select	select manual or auto ranging
Auto range	auto-range increase auto-range decline

	Name	Symbols And Meanings
Measurement parameters	Voltage current	Select RMS (the effective RMS value of voltage and current) . MEAN:(the rectified mean value calibrated to the RMS value of the voltage and the true RMS value of the current) . RMN (rectified mean value of voltage and current) DC:(simple average of voltage and current) AC: alternating current. PP: (peak value of voltage and peak value of current)
	Active power [W]	P
	Reactive power [var]	Q
	Apparent power [VA]	S
	Power factor	λ
	Phase difference (°)	Φ
	Frequency (Hz)	fU(FreqU) : voltage frequency fI(FreqI) : current frequency
	Max/min of voltage (V)	Upk+: voltage positive peak Upk-: voltage negative peak
	Max/min of current (A)	Ipk+: current positive peak Ipk-: current negative peak
	Crest factor	CfU: crest factor of voltage CfI: crest factor of current
Integration	TM: integration time, WP: sum of positive and negative watt hour, WP+: positive power sum, WP-: negative power sum, q: sum of positive and negative ampere-hour, q+: positive ampere-hour sum, q-: negative ampere-hour sum	
Measurement synchronization source	Select voltage , current, or the entire period of the data update interval for the signal used to achieve synchronization during measurement.	
Line filter	Select OFF or ON (cut off frequency at 500 Hz)	
Peak measurement	Measures the peak (max, min) value of voltage, current or power from the instantaneous current or instantaneous power that is sampled.	

Frequency Measurement

Item	Specifications	
Measurement item	Voltage or current frequencies applied to one selected input element can be measured	
Frequency filter	Varies depending on the data update interval (see description given later) as follows	
	Data update interval	Measurement range
	0.1 s	25 Hz \leq f \leq 100 kHz
	0.25 s	10 Hz \leq f \leq 100 kHz
	0.5 s	5 Hz \leq f \leq 100 kHz
	1 s	2.5 Hz \leq f \leq 100 kHz
Frequency filter	2 s	1.5 Hz \leq f \leq 50 kHz
	5 s	0.5 Hz \leq f \leq 20 kHz
	Select OFF or ON (cut off frequency of 500 Hz)	
Accuracy	Requirements : When the input signal level is 30 % or more of the measurement range and the crest factor is set to 3 (60 % or more if the crest factor is set to 6), Frequency filter is ON when measuring voltage or current of 200Hz or less. Accuracy: $\pm (0.06\% \text{ of reading})$	

Harmonic Measurement

Measured item	All installed elements
Method	PLL synchronization method
Frequency range	Fundamental frequency of the PLL source is in the range of 10 Hz to 1.2 kHz
PLL source	Select voltage of current of each input element
FFT data length	1024

	Name	Symbols And Meanings
measurement parameter	Voltage (V)	U(k) : voltage effective value of Kth harmonic U(Total) : voltage effective value
	Current (A)	I(k) : current effective value of Kth harmonic I(Total) : current effective value
	Active power (W)	P(k) : active power of Kth harmonic P(Total) : Active power
	Apparent power (VA)	S(k) : apparent power of Kth harmonic S(Total) : total apparent power
	Reactive power (var)	Q(k) : reactive power of Kth harmonic Q(Total) : total reactive power
	Power factor	$\lambda(k)$: power factor of Kth harmonic $\lambda(\text{Total})$: Total power factor
	Phase difference	$\phi(k)$: phase difference between voltage and current of Kth harmonic $\phi U(k)$: voltage phase difference between Kth harmonic(UK) and fundamental wave(U1) $\phi I(k)$: current phase difference between Kth harmonic(IK) and fundamental wave(I1) ϕ :total phase difference
	Harmonic distortion factor(%)	Uhd(k) : Voltage ratio of Kth harmonic(Uk) and fundamental wave(U1) Ihd(k) : active power ratio of Kth harmonic(Ik) and fundamental wave(I1) Phd(k) : wave(total) or total distortion wave(Utotal)
	(THD) total harmonic distortion	Uthd : voltage ratio of total harmonic and fundamental wave(U1) or total distortion wave(Utotal). Ithd : current ratio of total harmonic and fundamental wave(I1) or total distortion wave(Itotal). Pthd : active power ratio of total harmonic and fundamental wave(P1) or total distortion wave(Ptotal)
	Window function	Rectangle

Note

- This function is only available for IT9121, IT9121E doesn't have harmonic measurement function.
- K is a integer from 0 to upper limit of harmonic analyse times. 0th means DC parameter.
- User can configure the maximum number of harmonic times manually or auto-decided by equipment, taking the minimum value between the two methods.
- IT9121 can measure up to 50th harmonic.

Fundamental Frequency

Fundamental frequency	Sample rate	Window width	Upper limit of* analysis orders
10 Hz ~ 75 Hz	f * 1024	1	50
75 Hz ~ 150 Hz	f * 512	2	32
150 Hz ~ 300 Hz	f * 256	4	16
300 Hz ~ 600 Hz	f * 128	8	8
600 Hz ~ 1200 Hz	f * 64	16	4

* the upper limit of analysis orders can be decreased

Accuracy

* When line filter is off, the accuracy shown below is the sum of reading and range errors

Frequency	Voltage	Current	Power
10 Hz \leq f < 45 kHz	0.15%of reading +0.35%of range	0.15%of reading +0.35%of range	0.15%of reading +0.50%of range
45 Hz \leq f \leq 440 kHz	0.15%of reading +0.35%of range	0.15%of reading +0.35%of range	0.20%of reading +0.50%of range
440 Hz < f \leq 1 kHz	0.20%of reading +0.35%of range	0.20%of reading +0.35%of range	0.40%of reading +0.50%of range
1 kHz < f \leq 2.5 kHz	0.80%of reading +0.45%of range	0.80%of reading +0.45%of range	1.56%of reading +0.60%of range
2.5 kHz < f \leq 5 kHz	3.05%of reading +0.45%of range	3.05%of reading +0.45%of range	5.77%of reading +0.60%of range

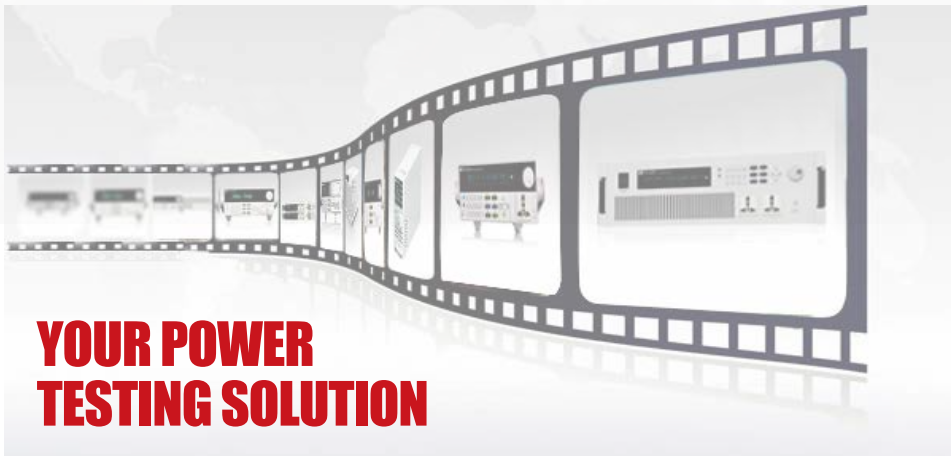
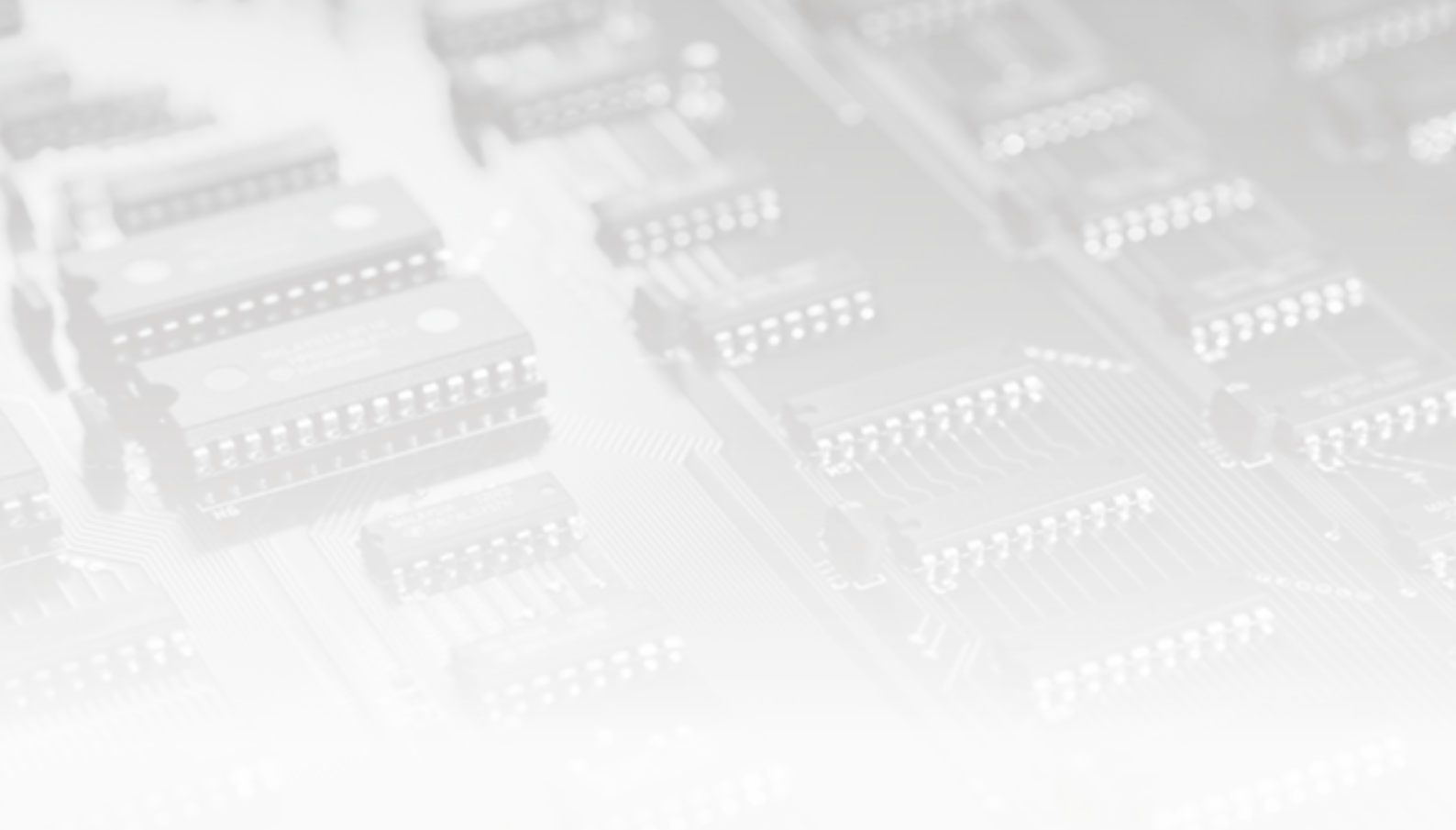

This information is subject to change without notice.

For more information, please contact ITECH.

www.itechate.com

Taiwan

TEL: 03-668-4333

FAX: 03-667-6466

E-mail: taiwan@itechate.com.tw

China

TEL: +86-25-52415098

FAX: +86-25-52415268

E-mail: info@itechate.com



ITECH